

OKAMURA CZ

A New Concept for Comfort

Instructions for Use



okamura

Parts names



Operating Range

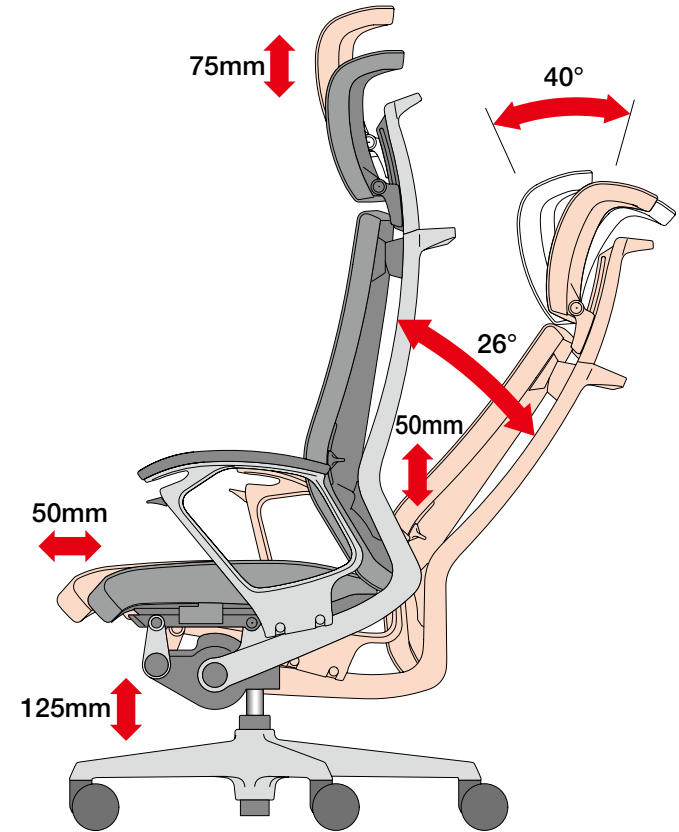

Operation guide

Seat height adjustment

This can be adjusted by holding the front end lever of the right armrest. If you hold the lever while putting your weight on the seat, the seat will lower. When you release the lever, the seat is locked in the desired position. To raise the seat, stand up from the seat while holding the lever.

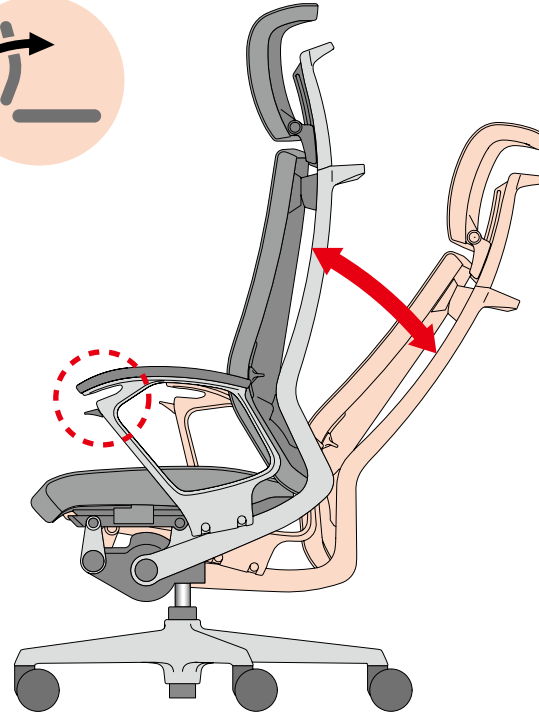
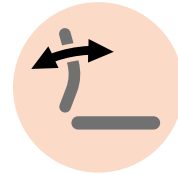
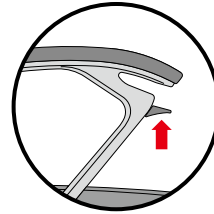
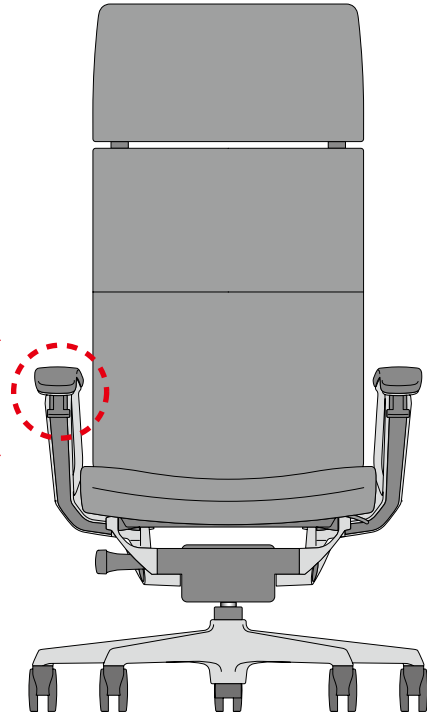
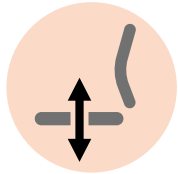
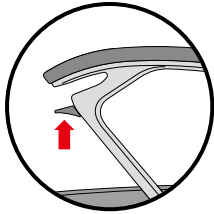

Tilt fixing / Releasing

This can be adjusted by holding and releasing the front end lever of the left armrest. Lean back and hold and release the lever in the reclined position to lock the back in position. Hold and release the lever again and then slightly put your weight on the back to unlock and return to free state.



Operation guide

Tilt tension adjustment

Tension of the back support can be adjusted by turning the grip located underneath the seat on the right hand side. The tension will increase in the order from 1 to 4 with the number positioned at the top of the dial. Adjust it to suit your needs.

Caution

Operate in the state of free locking without leaning against the backrest. Make sure to use in position 1, 2, 3 or 4. Do not use at some midpoint between those positions.

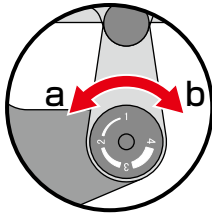

Turning the dial toward **a** (counterclockwise) decreases tension. 4 → 3 → 2 → 1

Turning the dial toward **b** (clockwise) increases tension. 1 → 2 → 3 → 4

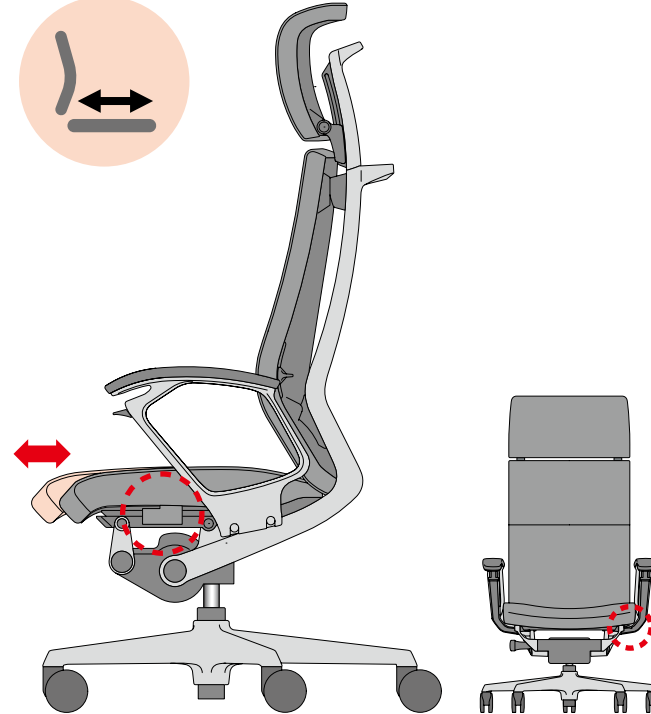
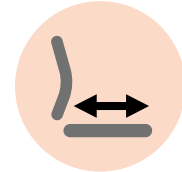
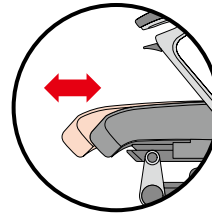
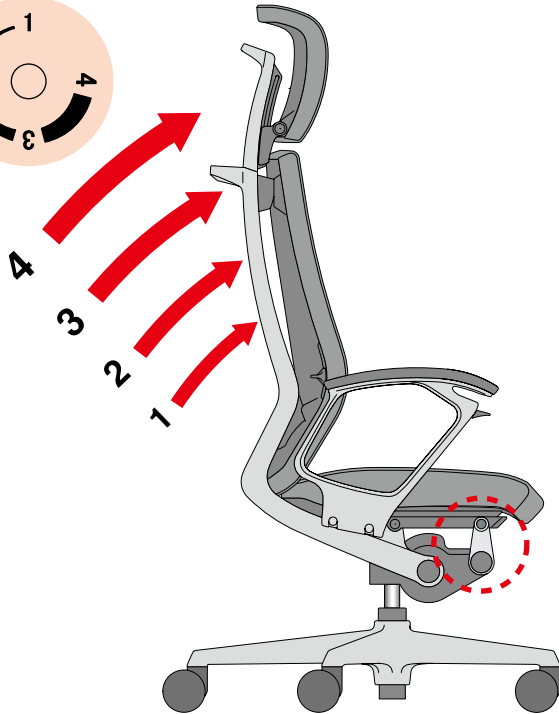
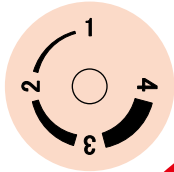

Seat depth adjustment

With the slide lever below the seat on the left hand side lifted, the seat slides backward and forward. Adjust it to suit your needs.

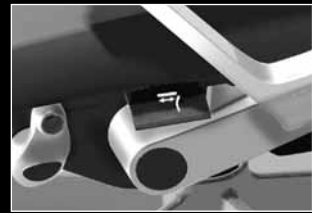

Operation guide

Lumbar support adjustment

The height can be adjusted by moving the back lumbar support lever up and down with both hands.

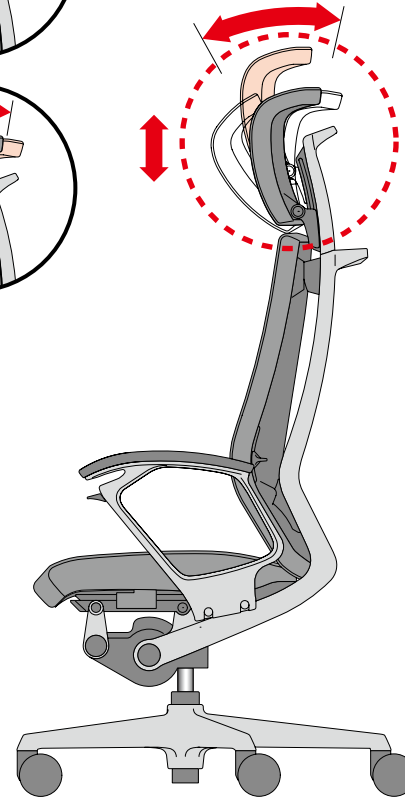
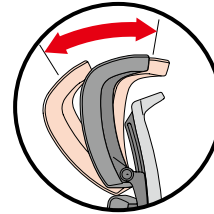
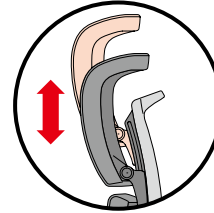
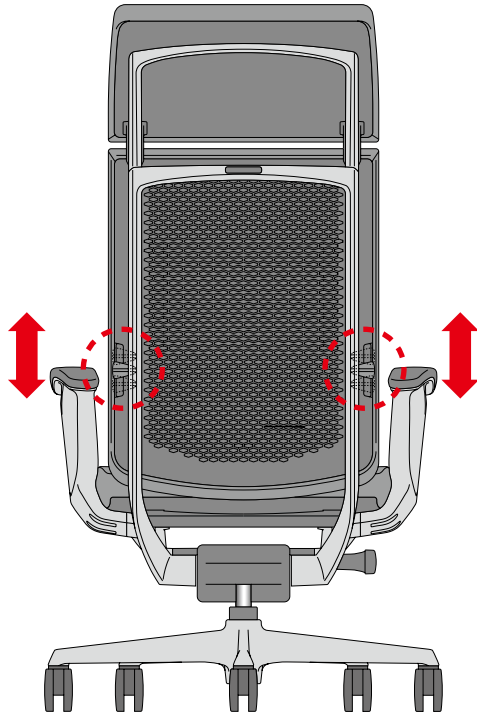
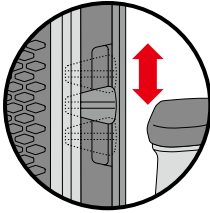

Adjusting headrest up and down, backward and forward

The headrest is adjustable up and down or backward and forward by turning it. Hold the upper part of the headrest and adjust slowly. Adjust it to suit your needs.



Main material

Part		Main material
Leg base	Base	Aluminum die cast }ADC<
	Casters	Polyamide }PA<
Frame	Frame below seat	Aluminum die cast }ADC<
	Slide rails	Aluminum die cast }ADC<
	Control lever underneath the seat	Glass reinforced polyamide }PA-GF<
	Back frame	Aluminum die cast }ADC<
Back	Back shell	Polyamide }PA<
	Back inner shell	Polypropylene }PP<
	Back cushion	Polyurethane }PUR<
Seat	Seat shell	Glass reinforced polyamide }PA-GF<
	Seat cushion	Polyurethane }PUR<
Headrest	Frame	Aluminum die cast }ADC<
	Rails	Polyacetal }POM<
	Outer shell	Polypropylene }PP<
	Inner shell	Polyamide }PA<
Armrests	Cushion	Polyurethane }PUR<
	Arm frame	Aluminum die cast }ADC<
	Arm pad	Polyurethane }PUR<
	Control lever	Glass reinforced polyamide }PA-GF<

* The marks }□□□< indicate material identification code number. This should be used for recycling.

Check below before suspecting it is defective

Description of problem	Items to be checked	Solution	Reference page
The seat cannot be raised.	Aren't you adjusting it while putting your weight on the seat?	Operate when standing up.	3
	Isn't the seat in the highest position?	Use at the height below the highest position.	3
The seat cannot be lowered.	Aren't you adjusting it while you are seated at the front?	Operate it while putting your weight on the central area of the seat.	3
	Isn't the seat in the lowest position?	Use at the height above the lowest position.	3
The seat does not move backward and forward.	Aren't you adjusting it while putting your weight on the seat?	Operate when standing up.	6
The tension control dial does not turn.	Is the backrest locked?	Operate the lever on the left armrest to place in free mode so the backrest moves when leaned back.	5
The backrest does not move.	Isn't the lever below the left armrest set in the locked position?	Click the lever and release it, and then lean against the backrest.	4
	Isn't the recline tension control dial on the reverse side of the seat set to firm (direction toward 4)?	By turning the recline tension control dial counterclockwise, set to 1 or 2.	5
	Isn't the backrest stopped in a position other than the original position (most upright) and isn't the tension control dial stopped in the position between 1 and 2?	When the tension control dial turns: Turn the dial counterclockwise to set to 1. Then, click the lever on the left armrest and release it, and then strongly lean against the backrest. Repeat the same operation several times and reconfirm that the tension control dial is properly set to 1 when the backrest returns to the original position. When the tension control dial does not turn. Click the lever on the left armrest and release it, and then strongly lean against the backrest. Repeat the same operation several times and properly set the tension control dial to 1 by turning it anticlockwise when the backrest returns to the original position.	
Casters do not roll smoothly.	Aren't casters tangled with foreign objects (e.g. lint and yarn)?	Remove foreign substances or replace the casters with new ones.	Contact the store or our sales representative.
Casters roll excessively.	Is the floor hard finished with plastic tiles or wood?	It is recommended to replace the casters with urethane ones.	
Chair makes noise.		Contact the store you purchased from or our branch.	

okamura

OKAMURA CORPORATION

INTERNATIONAL SALES & MARKETING DIVISION
2-14-27, Akasaka, Minato-ku, Tokyo 107-0052, JAPAN

Tel : +81-3-5561-4085 Fax : +81-3-5561-4086

<http://www.okamura.jp>

G96376
2010-04