

m o o o i[®]



Container Table

by Marcel Wanders

Designer	Marcel Wanders
Year of design	2001
Material	Container Foot: PE, Top: HPL, LPL, Laquered Wood, Stained Wood, Linoleum

m o o o i

Dimensions

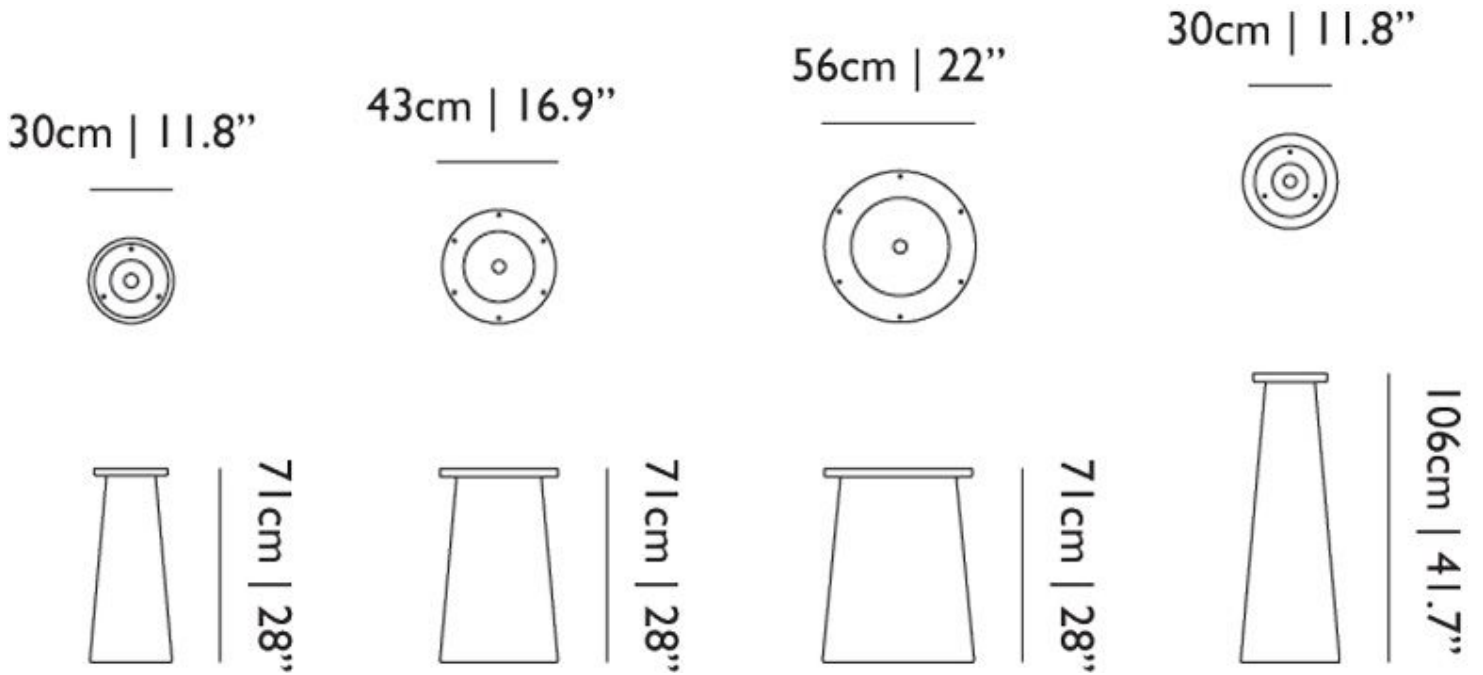

Dimensions New Antiques

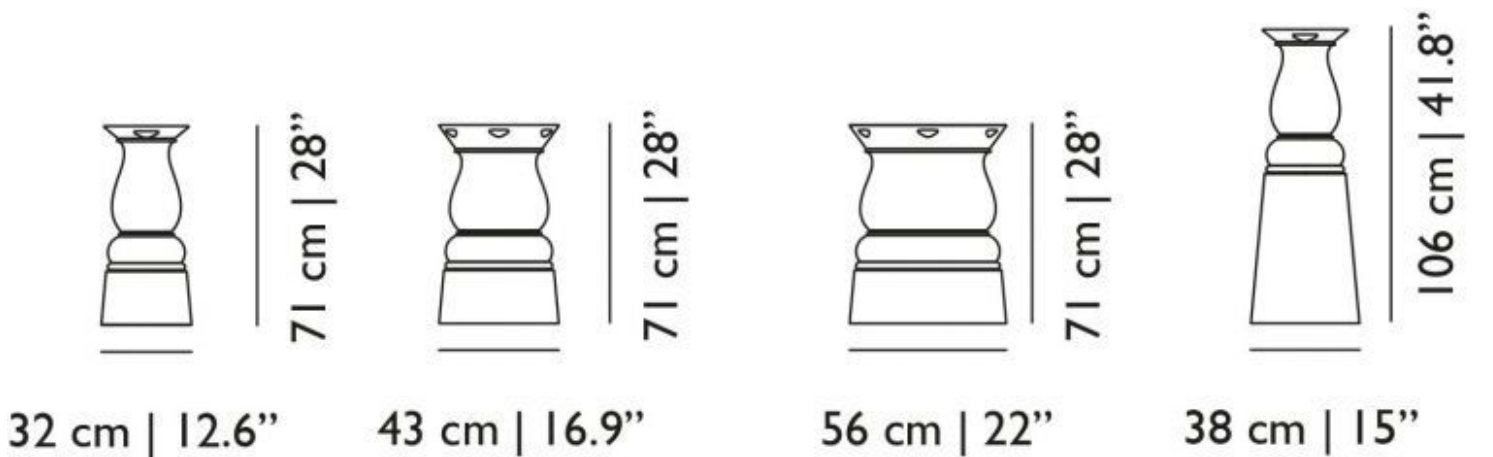

Foot colours

Foot Colours



Light Grey, Ral
7035



Terracotta, Ral
2013



Concrete, Ral
7013 + 7006

White, Ral 9002



Black, Ral 9017

The container Tops are available in the following materials and colours:



HPL, A flat panel based on thermosetting resins, homogeneously reinforced with woodfibres and manufactured under high pressure and at high temperatures:

Thickness top 1.2cm | 0.5"

Also for outdoor use

Available in white, black and light grey. The trim is always black.



Oak veneer, stained and lacquered:

Thickness top 4cm | 1.6"

For indoor use only

Available in the 6 Moooi stain colours, and 25 Moooi Ral Colours

m o o o i[®]



Linoak:

Thickness top, 4cm | 1.6"

For indoor use only

The solid oak edge is available in the 6 Moooi stain colours, the linoleum centre is available in Mauve, Pewter and Nero.

The container feet are available in the following shapes and colours



Classic - In colours: White, Black, Light Grey, Terracotta, Concrete



New Antiques - In colours: White, Black, Light Grey, Terracotta, Concrete





Bodhi Cover - In colours: Black, Cinnamon, Grey, Natural Oil, Wenge, White Wash

Container General

The container table top range all attached to the container foot in the same way. The container concept is that sand, pebbles or water can be added to the foot to give it strength and stability. Water must always be treated with an anti-algae additive to prevent the water from becoming stale. There are Hex-bolts on the underside of each table which align with equally spaced holes in the container foot.

Container Table options

CONTAINER FAMILY						Top			FOOT	dining table
									 Classic	7156 71cm 28" x 56cm 22.1"
									 Bodhi	7156 71cm 28" x 56cm 22.1"
									 New Antiques	7156 71cm 28" x 56cm 22.1"
Shape	L	W	HPL	Wood	Linoak	<i>Number of feet required</i>				
Oval	210cm 82.7"	135cm 53.1"		x	x					
Round	∅	160cm 63"	x	x	x					
Round	∅	180cm 70.9"	x	x	x					
Square	160cm 63"	160cm 63"	x	x	x					

HPL colours

HPL tops are available in the following colours

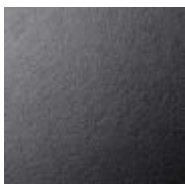

Black

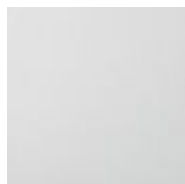

Grey

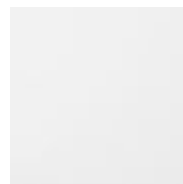

White



Container table top - Linoak

The center of the Linoak top is made of linoleum, and available in the following colours. The solid oak edge is available in one of the 6 mooi stain colours.

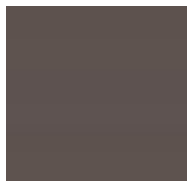

mauve



nero



pewter

Wood Stained Colours for Container Table top, Bodhi covers & Zio family

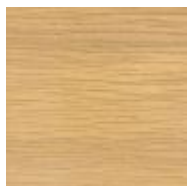

White Wash



Wenge

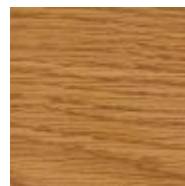

Natural Oil



Grey

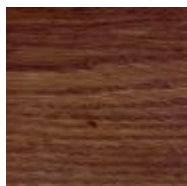

Cinnamon



Black Stained

Container Table Top - Ral Colours

Available RAL Colours:

1004 1013 1023 1027 2000 2002 2004 3012 3015 5003 5008 5024 6010 6021 7001 7011 7035 7044 8001
8014 8016 9005 9010 9016 3003

m o o o i[®]



RAL 1004

.



RAL 1013



RAL 1023



RAL 1027



RAL 2000



RAL 2002



RAL 2004



RAL 3003



RAL 3012

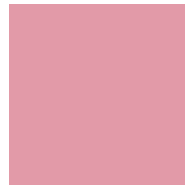

RAL 3015



RAL 5003



RAL 5008



RAL 5024



RAL 6010



RAL 6021

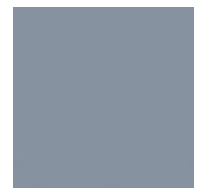

RAL 7001



RAL 7011



RAL 7035



RAL 7044



RAL 8001

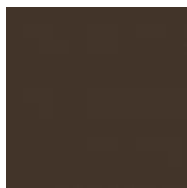

RAL 8014

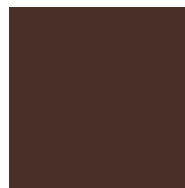

RAL 8016



RAL 9005

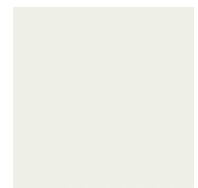

RAL 9010

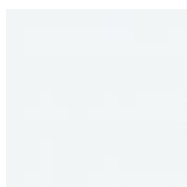

RAL 9016