

REPORT

## OFFICE CHAIR. ERGONOMIC EVALUATION



Addressed to: **FORMA 5 S.L.U.**

Drawn up by: **INSTITUTO DE BIOMECÁNICA DE VALENCIA**

Universidad Politécnica de Valencia · Edificio 9C

Camino de Vera s/n · E-46022 · VALENCIA (ESPAÑA)

Tel.: 96 387 91 60. Fax: 96 387 91 69

**ibv@ibv.upv.es** – **WWW.IBV.ORG**

OCTOBER 2012



## **SIGNATURES AND AGREEMENT CONDITIONS**

---

Area: IBV - TESTING

Report drawn up by: Mr. José Francisco Serrano Ortiz, Technician of the Inspection and Testing product line of the IBV

Signed:



Date: 5/10/12

Checked by: Ms. Amelia Gómez Pérez, Coordinator of the Inspection and Testing product line of the IBV

Signed:



Date: 5/10/12

Approved by: Ms. Inés Pereira Carrillo, Head of the Inspection and Testing product line of the IBV

Signed:



Date: 5/10/12

## **AGREEMENT CONDITIONS**

1. The Biomechanics Institute of Valencia (IBV) is only responsible for the results recorded in this report and exclusively referring to the materials or samples that are given therein and that are in their possession. Unless specifically mentioned, the samples have been freely chosen and sent by the applicant.
2. IBV is not responsible for the erroneous interpretation or inadequate use that is made of this report, whose partial or total reproduction for publicity purposes, without the express authorisation of IBV is prohibited.
3. The results of this report are the property of the applicant and without previous authorisation by IBV, they may not be communicated to third parties.
4. Unless the opposite is stated, the sample or samples of the tests in this report will remain on the IBV premises for a period of six months after the date the report is issued. Once this period is over, they will be destroyed and therefore any claims must be made within this period.

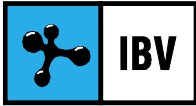

**C O N T E N T**

SIGNATURES AND AGREEMENT CONDITIONS

1. INTRODUCTION, BACKGROUND AND OBJECTIVES

2. MATERIAL AND METHODS

3. RESULTS

ANNEX

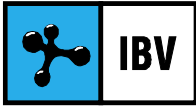

## 1. INTRODUCTION, BACKGROUND AND OBJECTIVES

---

The objective of the test is the ergonomic evaluation of an office chair according to procedures of the IBV.

The evaluation carried out covers the following aspects:

- 1. Evaluation of the dimensional and functional suitability.** Correspondence between the dimensions of the product and the use it is intended for.
- 2. Temporary evolution of the general comfort and discomfort in different parts of the body.** To check if the comfort and discomfort levels are stable or if they undergo changes during a typical period of use.
- 3. Relationship between discomfort in parts of the body and general comfort.** To establish if there is a relationship between the discomfort that increases with time and general comfort.
- 4. Subjective perception of the characteristics of the chair.** To consider the opinion of the population regarding the design characteristics.
- 5. Pressure distribution.** To detect possible problems with the chair regarding comfort and functionality related to inadequate distribution of pressure on the seat.
- 6. Analysis of the use of the backrest.** To check that the design of the backrest allows correct support of the back in the lumbar and dorsal regions.

The tests were requested by the company: FORMA 5, S. L. U., located at: C/ Acueducto, 12-14. 41703- Dos hermanas. Sevilla.



## 2. MATERIAL AND METHODS

---

The coding and description of the sample is shown in the following table:

CODE	DESCRIPTION	UNITS
MU12-0196	Office chair SENTIS Series: mesh backrest, swivel chair. Features: <ul style="list-style-type: none"><li>• Backrest seat synchro mechanism</li><li>• Seat high regulation</li><li>• Seat depth regulation</li><li>• 3D adjustable armrests</li><li>• Lumbar support regulation</li></ul>	1



Mu12-0196

The test sample will be delivered to the client after the tests have been finished.

The tests were carried out, under ambient conditions of 22°C and 55% humidity level.

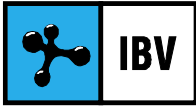

The study carried out consists of three types of tests:

**Dimensional suitability tests.** Geometrical measurements of concordance between the dimensions of the product and the use it is intended for.

**Comfort tests.** Subjective tests in which the overall level of comfort, discomfort in specific parts of the body and general opinion regarding certain characteristics of the product are quantified through the use of questionnaires filled in by potential users.

**Biomechanical tests.** Objective tests in which certain corporal parameters related to comfort levels of the subjects are measured such as the distribution of pressure on the seat and the level of use of the backrest.

## 2.1 DIMENSIONAL SUITABILITY TESTS.

The measurements were taken using a backrest and seat load simulator built by IBV in accordance with the Swedish standard SS 839140. This device permits us to obtain measurements under conditions similar to those of use, bearing in mind the distribution of the loads a standard user applies to the seat and the backrest.

The dimensions measured were as follows:

### Dimensions of the seat

The basic dimensional functions of the seat are as follows (Figure 1):

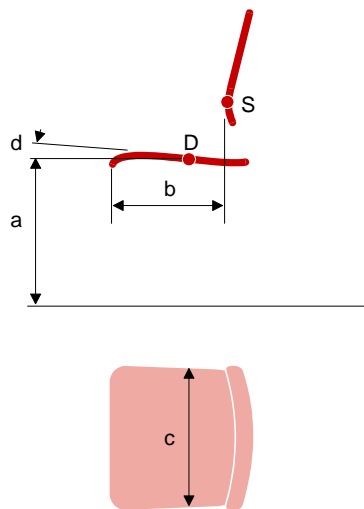

Figure 1. Functional dimensions of the seat.



- (a) *Seat height.* The seat height refers to the height from the floor to the maximum support point of the seat, which corresponds to the ischiatic bones.
- (b) *Useful depth of the seat.* The distance between the front edge of the seat and the projection over it of the nearest point of the backrest (point S).
- (c) *Seat width.* The width of the seat measured at the maximum support point of the seat.
- (d) *Seat tilt.* The angle described between the plane of the seat to the horizontal. Forward tilts are known as positive tilts (front edge down) and backward tilts are negative tilts (front edge up).

### Backrest dimensions

The functional dimensions of the backrest are as follows (Figure 2):

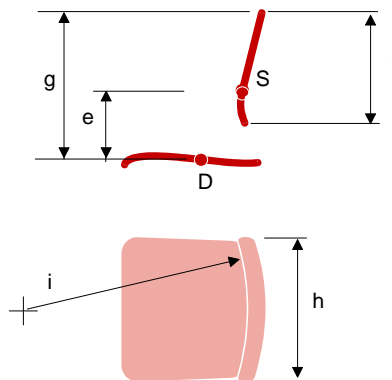

Figure 2. Functional dimensions of the backrest.

- (e) *Height of the lumbar region over the seat.* The vertical distance between point S of the backrest and point D of the seat.
- (f) *Height of the backrest.* The vertical distance between the upper and lower edges of the backrest.
- (g) *Height of the upper edge of the backrest.* The vertical distance between the upper edge of the backrest and point D of the seat.
- (h) *Width of backrest.* This is the maximum width the backrest has in the range of: the height of point S (lumbar region support) and the height of S + 300.
- (i) *Curvature radius of the horizontal profile of the backrest.* This measurement is taken horizontally at point S of the backrest.
- (j) *Field of regulation of the tilt of the backrest.* This is the tilt range of the backrest from the vertical plane.



### Dimensions of the armrests

The functional dimensions to be considered when dealing with armrests are as follows (Figure 4):



Figura 4. Dimensiones funcionales de los reposabrazos.

- (k) *Useful length of the armrests.* Horizontal distance between the useful extremes of the armrests.
- (l) *Useful width of the armrests.* Width of the armrests at the same level as point D.
- (m) *Height of armrests.* The height of the armrests is measured from the seat, taking the maximum support point (point D) as a reference.
- (n) *Distance from front edge of armrest to front edge of seat.* This position is determined by the horizontal distance between the front edge of the armrests and the front edge of the seat.
- (o) *Distance between armrests.* The horizontal distance between the inner edges of the armrests, measured on the transversal plane at the height of point D.

### Dimensions of the chassis

The dimensions to be considered in the definition of the chassis are as follows (Figure 5):

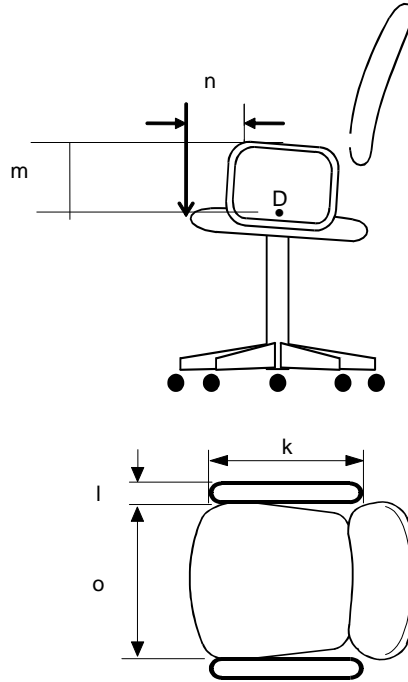

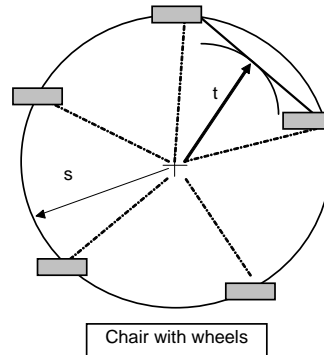
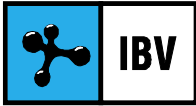

Figure 5. Dimensions of the chassis.

Figura 5. Dimensiones del bastidor.

- (s) *Maximum projection of the chassis.* The maximum distance between the outermost point of the chassis and the rotation axis of the chair.
- (t) *Stability scale.* The minimum distance of support from the joining line between two adjacent points and the rotation axis of the chair.

The support points are the fixed or mobile points of the chair that are in constant contact with the floor. When wheels are used they are always placed in the most unfavourable positions.

## 2.2. COMFORT TESTS

During the comfort tests subjective responses have been analysed from the users based on the procedure as described by Shackel and by Corlett and Bishop. This procedure is based on three types of tests.

- General comfort test.
- Tests for discomfort on parts of the body.
- Subjective opinions about the characteristics of the product.

These tests were carried out in the Ergonomics laboratory at the IBV, simulating real conditions of use of the product. In order to do so, two office posts were set up. The sample of users who took part in the tests comprised 12 subjects (6 men and 6 women).

Each of the tests lasted for 1.5 hours, having observed the following test protocol.

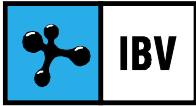

- 1) The subject sat on the chair to be evaluated in order to carry out the task in question without receiving any indications as to the posture that should be adopted. In this way spontaneous behaviour could be evaluated. The subjects were explained about the use of the adjustments of the chair or it was adjusted by the technician.
- 2) At the start of the test the subject filled in the relevant questionnaires for the general comfort test and the test for discomfort on parts of the body. In the former, the subject had to state his/her level of comfort at that time, on a scale of 9 points (1 = completely relaxed, 9 = very uncomfortable). In the latter, they had to mark off the points of the body where discomfort or pain appeared on a scale of 5 points (5 = pronounced discomfort or pain; 1 = slight discomfort; no score = absence of discomfort in that part of the body).
- 3) The aforementioned questionnaires were filled in 30, 60 and 90 minutes later. Each questionnaire was taken away once it was filled in to avoid the previous answers having an influence on the following ones.
- 4) Once the test was finished, the subject answered a test on subjective opinions about the characteristics of the product, where they were asked about specific aspects of it.

From the responses obtained through the **general comfort test**, the evolution in time of the discomfort level was analysed, establishing whether or not there was a significant increase in the level and evaluating the overall response concerning the ranges of normality of tests with other models of chairs. Through this process, the general level of comfort of the tested product could be established.

The information obtained from the **discomfort on parts of the body tests** is useful for:

- a) Determining the evolution in time of the discomfort level in those parts of the body mentioned by the users. In this way it could be checked if the level of discomfort on different parts of the body increased continually or if it became stable and the importance of the maximum level of discomfort reached could be evaluated.
- b) Once those parts of the body where discomfort appeared through the use of the product had been selected, we then moved on to analyse which were associated with the increase in the overall discomfort level. This analysis allowed for the selection of parts that were affected by discomfort enough to produce a negative overall sensation through the use of the product.

The subjective opinion test regarding the characteristics of the product allows for the detection of, in the first stage, those characteristics of the piece of furniture that are most unsuitable in the opinion of the users, and secondly it permits a comparison of the evaluation of each point with normal ranges from analyses of other chair models.



## 2.3. BIOMECHANICAL TESTS

The results obtained from these tests permit the assessment of the objective causes that give rise to the significant discomfort mentioned in the previous section.

The tests carried out are:

- Analysis of the pressure distribution over the seat. This variable is usually associated with the possibility of discomfort in the buttocks and thighs.
- Analysis of the use of the backrest. This variable is usually associated with the appearance of possible discomfort in the back (lumbar or dorsal regions).

The tests consist of the following:

- a) **Analysis of the distribution of pressure points on the seat.** The distribution of pressure points on the seat is measured by sitting a subject on the seat and placing a system of pressure sensors between the subject and the seat "Xsensor". The aforementioned test were carried out on the seat, comparing the maximum pressure values with the serious discomfort limit values.

From the recording obtained, the following parameters were measured for each subject who sat in the chair:

- Maximum pressure (pressure on the support area of the ischiatic bones).
- Average pressure.

- b) **Analysis of the use of the backrest.** One of the factors that greatly reduces the appearance of discomfort in different parts of the body while maintaining a sitting position, is the presence of a backrest that provides suitable support for the lumbar region and that prevents the trunk of the body from adopting bent or very straight postures. In order to measure the degree and way of using the backrest, a device consisting in a group of flexible electrodes was used. The electrodes are extremely fine and are fitted to the backrest and on different parts of the subject's back. From the different combinations of contact between the electrodes on the subject's back and the backrest, it can be determined if the subject is using the backrest or not and how it is being used, i.e., if the subject receives support to the lumbar region or if not, if slouching occurs. During each session of use of the backrest, the subject sat for 1.5 hours on the chair being tested, while at the same time carrying out comfort tests.



The equipment used for the carrying out of the tests is shown in the following table:

EQUIPMENT
Thermo-hygrometer
Chair measuring equipment
Reference dummy
Tape measure
Digital inclinometer
Calibre
XSENSOR Pressure recording system
Weigh scales



### 3. RESULTS

#### 3.1 DIMENSIONAL SUITABILITY

The following table shows the results of the measurements taken:

DIMENSION	MU12-0196		CRITERIA	VALUATION
	Backrest forward	Backrest back		
<b>SEAT</b>				
Height (mm)	397-497	336-436	≤400 - ≥510	Suitable
Height regulation (mm)	100		≥120	Not suitable
Useful depth (mm)	434-485	476-527	≤400 - ≥420	Not suitable
Depth regulation (mm)	51		≥50	Suitable
Width (mm)	460		≥400	Suitable
Tilt (°)	-0,81	-5,77	≤(-2) - ≥(-7)	Not suitable
Regulation d (°)	4,96		≥6	Not suitable
<b>BACKREST</b>				
Height of top edge (mm)	526		≥360	Suitable
Width (mm)	448		≥360	Suitable
Curvature radius of the horizontal profile (mm.)	3140		≥400	Suitable
Height of lumbar support (mm)	161-224		≤170 - ≥220	Suitable
Height regulation (mm)	63		≥50	Suitable
Tilt angle (°)	11,2 – 38,2		-	-
Tilt regulation (°)	27		≥15	Suitable
<b>ARMRESTS</b>				
Useful length (mm)	250		≥200	Suitable
Useful width (mm)	84.5		≥40	Suitable
Height (mm)	213 - 313		≥200 - ≤250	Suitable
Height regulation (mm)	100		-	-
Distance to the front edge of seat (mm)	122 - 172		≥100	Suitable
Distance between armrests (mm)	485		≥460 - ≤510	Suitable
<b>CHASSIS</b>				
Maximum projection (mm)	382		≤415	Suitable
Stability level (mm)	486		≥195	Suitable

VALUATION OF THE DIMENSIONAL SUITABILITY. IMPROVABLE



### 3.2 COMFORT TESTS

The comfort tests were carried out using the procedure explained in the previous chapter with a sample of 12 subjects, 6 men and 6 women, with the following corporal characteristics (average ± typical deviation):

SAMPLE OF TEST SUBJECTS:

	Size	Weight
<b>Men</b>	173.3 ± 5.3 cm	75.3 ± 9,3 kg
<b>Women</b>	159.8 ± 4.2 cm	60.5 ± 5.6 kg

#### General comfort test

Figure 1 shows the evolution in time of the level of general discomfort over a period of 1.5 hours. The graph shows the average values and the interval of 95% LSD. The discomfort scores are those taken from the aforementioned comfort test (1 = completely relaxed, 2 = very comfortable, 3 = fairly comfortable, 4 = comfortable, 5 = normal, 6 = slightly uncomfortable, 7 = uncomfortable, 8 = fairly uncomfortable, 9 = very uncomfortable).

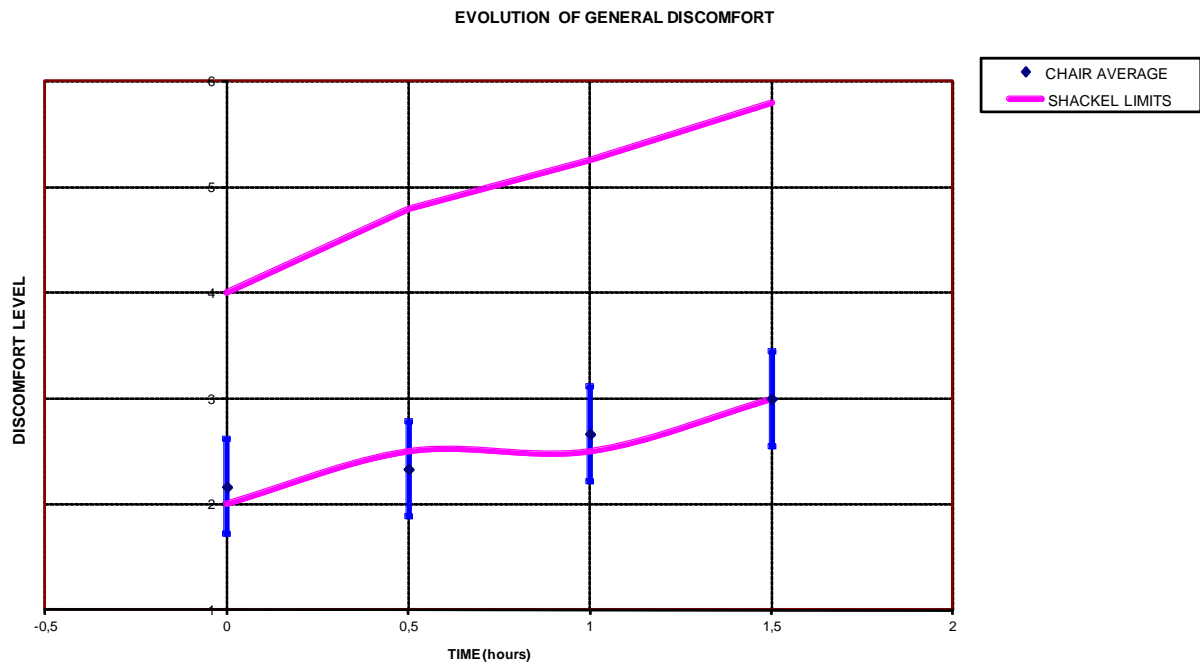
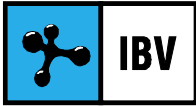

Figure 1. Evolution in time of the discomfort level.



As can be seen, the levels of general comfort in the chair vary, both at the beginning of the test and throughout the whole time scale, between the situations of **very comfortable** to **quite comfortable**. The evolution of the discomfort throughout the test shows how the behaviour of the chair evolves with time between the zones of very comfortable to quite comfortable.

On the other hand, Figure 2 shows the evolution of the general comfort level of the tested chair compared to the range established by IBV for office chairs.

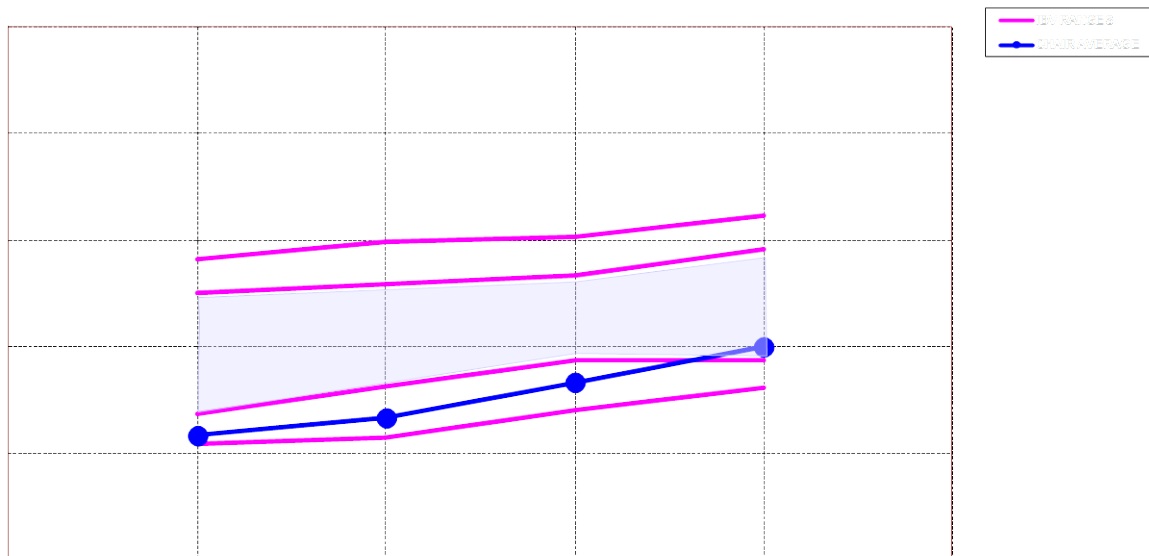

Figure 2. Evolution in time of general comfort IBV Ranges

In this graph it can be seen that only during the last half hour of the test is within the established range, having previously performed particularly comfortable.

No discomfort seen increased statistically significant over time.

VALUATION OF THE GENERAL COMFORT TEST: GOOD

**Test for discomfort on parts of the body**

One of the objectives of this test is to select those parts of the body where discomfort arises that is significant enough to affect the overall comfort of users.

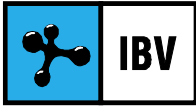

In order to do so, the evolution in time was analysed regarding the level of most frequent discomfort (neck, dorsal, lumbar and buttocks).

Figures 3 and 4 show the average values of the significant discomfort increases observed (in dorsal area and buttocks) with indication of the confidence interval 95% LSD.

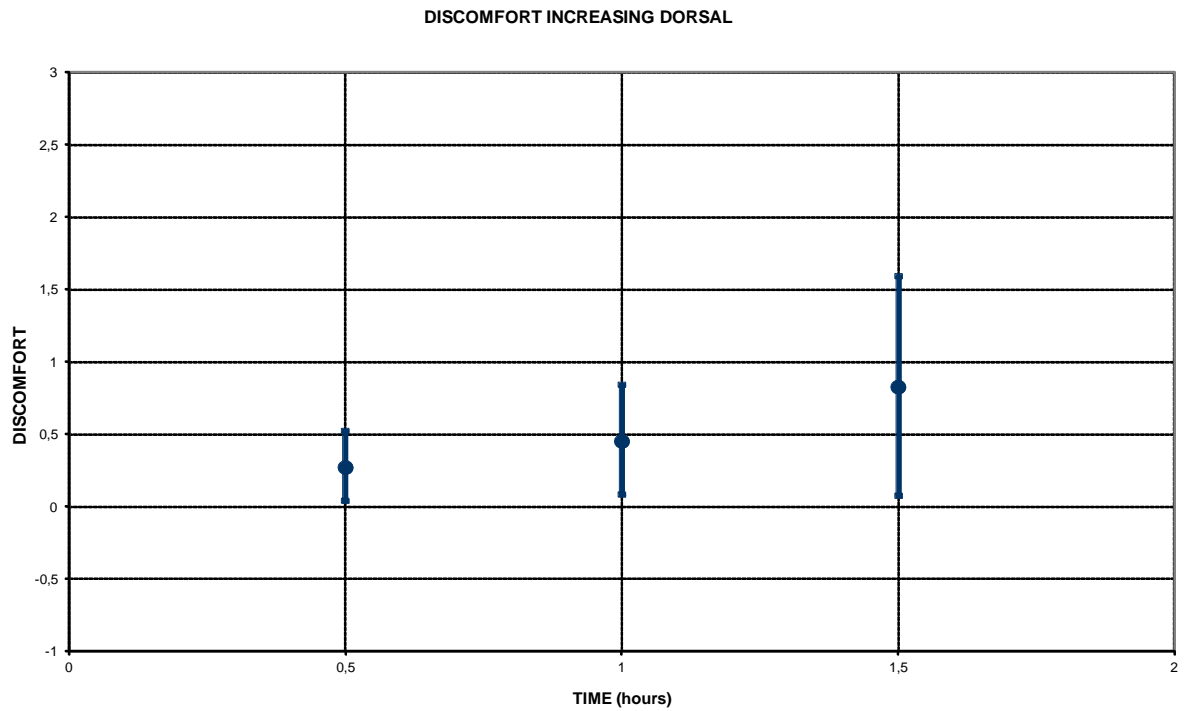

Figure 3. Evolution of discomfort in the dorsal



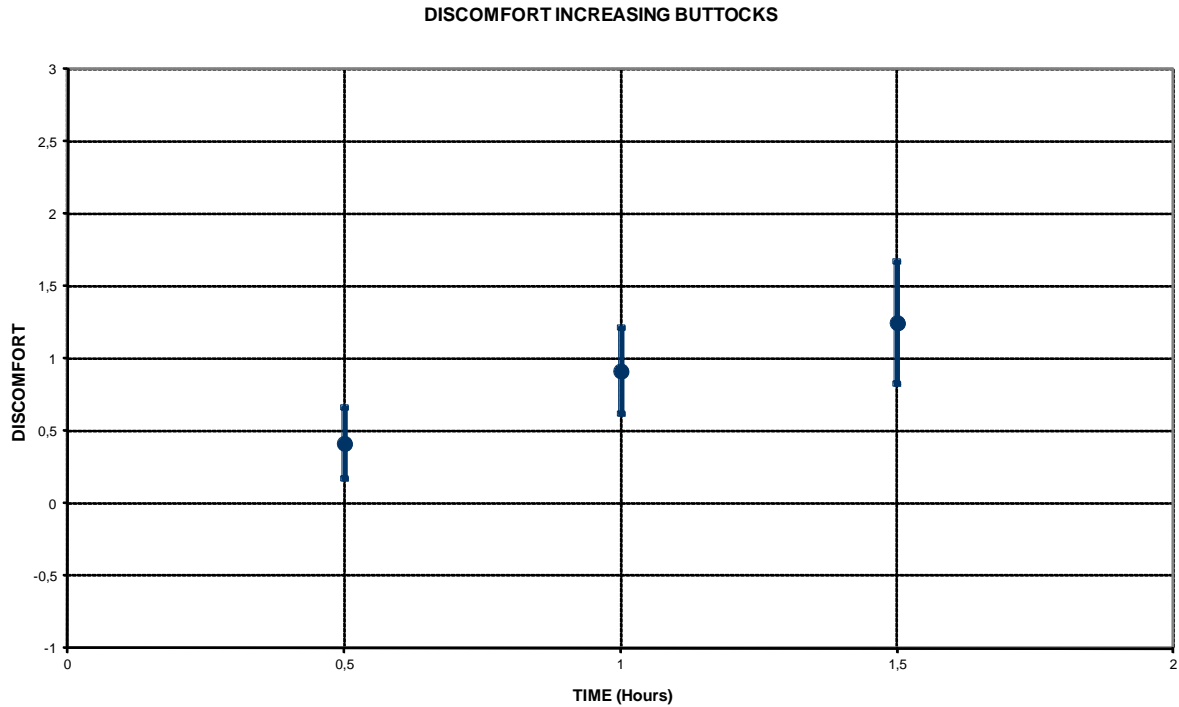

Figure 4. Evolution of discomfort in the buttocks

The following table (Figure 5) answers the question of which of the discomfort increased over time are related to the increased level of discomfort.

Correlaciones			
	ICONF	IESP	INAL
ICONF		0,3088 (,72) 0,0083	0,4557 (,72) 0,0001
IESP	0,3088 (,72) 0,0083		0,3002 (,72) 0,0104
INAL	0,4557 (,72) 0,0001	0,3002 (,72) 0,0104	

Figura 5. Correlation between discomfort and general comfort

There is statistically significant correlation between increasing discomfort over time (dorsal and buttocks) and general comfort with a significance level of  $\alpha < 0.05$ .

Therefore, the increased discomfort in the back and buttocks with time is significantly associated with increased discomfort.

VALUATION OF THE TEST FOR DISCOMFORT ON DIFFERENT PARTS OF THE BODY - IMPROVABLE



### Test de juicios subjetivos sobre características del producto

Table 6 includes the results of the evaluation of the characteristics that the subjects were asked to evaluate. In the figures in Annex 1, the evaluations are represented graphically through the use of two inverted triangles that correspond to the frequency of the appearance of negative opinions due to excess and due to fault. Colour bands show the normal area in one case and in the other case they show the comparison with other chairs analysed by IBV.

**CAN IMPROVE**

**ACCEPTABLE**

**CORRECT**



*TABLA 6. CHARACTERISTICS OF THE CHAIR EVALUATED BY THE SUBJECTS*

<b>CARACTERÍSTICAS DIMENSIONALES SILLA</b>	<b>VALORACIÓN</b>
Seat height.	Correct
Seat depth.	Correct
Seat material.	Correct
Seat shape.	Correct
Does the front edge dig in?	No
<b>Separation between armrests</b>	
Separation between armrests	Correct-Excessive
Height of the armrests	Correct
Width of the armrests	Correct
Length of the armrests	Correct
Shape of the armrests	Correct
<b>Altura del borde superior del respaldo.</b>	
Altura del borde superior del respaldo.	Correct
<b>Anchura del respaldo.</b>	
Anchura del respaldo.	Correct
<b>Altura del apoyo lumbar.</b>	
Altura del apoyo lumbar.	Correct
<b>Perfil vertical del respaldo</b>	
Perfil vertical del respaldo	Correct
<b>Perfil horizontal del respaldo</b>	
Perfil horizontal del respaldo	Correct-Too curved
<b>¿Se clava alguna zona del respaldo?</b>	
¿Se clava alguna zona del respaldo?	No
<b>Material del respaldo</b>	
Material del respaldo	Correct
<b>Valoración global de la silla</b>	<b>Entre Muy Cómoda y Cómoda</b>

<b>REGULACIÓN DE LA ALTURA DEL ASIENTO</b>	<b>VALORACIÓN</b>
Facilidad para regular la altura	Normal-Easy
Acceso al mando de regulación	Normal
<b>REGULACIÓN DE PROFUNDIDAD DEL ASIENTO</b>	
Facilidad para regular la profundidad	Normal-Easy
Acceso al mando de regulación	Normal- Comfortable
<b>BLOQUEO DEL RESPALDO</b>	
Facilidad para bloquear el respaldo	Normal-Easy
Acceso al mando de bloqueo	Normal-Complicated
<b>REGULACIÓN DE LA SUJECIÓN LUMBAR</b>	
Facilidad para regular la sujeción lumbar	Easy
Acceso al mando de regulación	Comfortable
Dureza del mando de regulación	Correct
<b>REGULACIÓN ALTURA DEL REPOSABRAZOS</b>	
Facilidad para regular la altura	Easy
Acceso al mando de regulación	Comfortable



**BIOMECHANICAL TESTS**

**Analysis of pressure distribution**

The maximum pressure is that related to the appearance of discomfort problems, as maximum pressures over 40 kPa give rise to discomfort in most users. Table 7 shows the results from the measurements taken regarding the distribution of pressure on the seat.

CHAIR	Pmax (kPa)	Pmed (kPa)	Super. (cm <sup>2</sup> )
<b>MU12-0196</b>	10.07	5.16	1065.77

TABLE 7. Maximum and average pressure in the chair

In this table, it can be seen that the chair provides a suitable weight distribution of the users with **maximum pressures that do not exceed the limit of 40 kPa**.

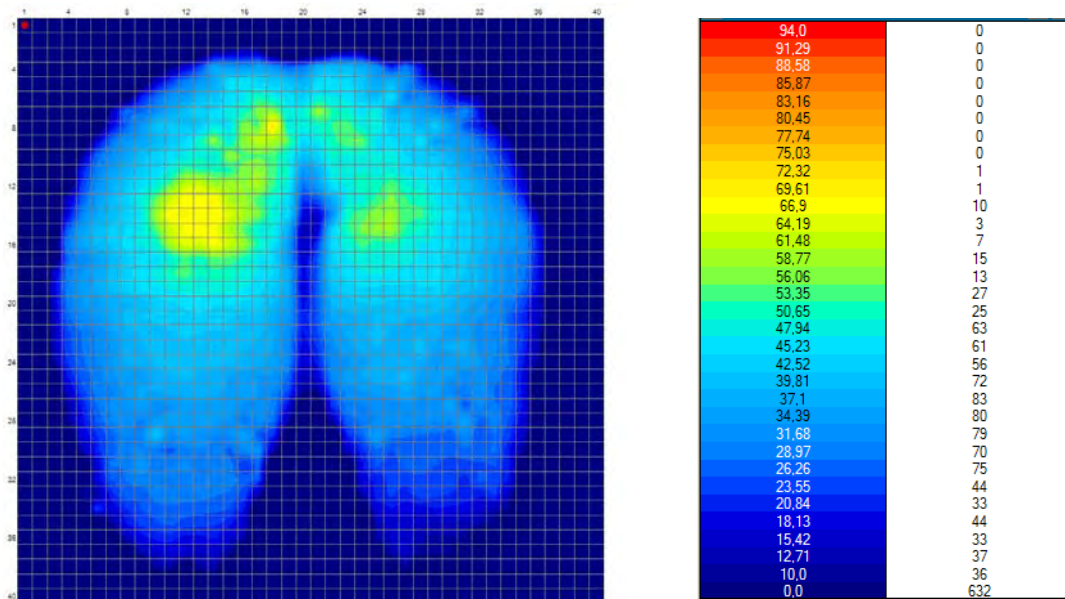

VALUATION ANALYSIS PRESSURE DISTRIBUTION. GOOD



**Use of the backrest**

In these tests the percentage of time the backrest was used was recorded, and at the same time what kind of use it was put to. To do so, a device designed by IBV was used that allows recording contact between the back of the subject (lumbar and dorsal regions) and the backrest of the product. In Table 8 the average values of the percentage of times of contact are shown for the two regions of the back and the percentage of time without any contact at all.

*TABLE 8. Percentage of time the back regions use the backrest*

	<b>MU12-0196</b>
NO SUPPORT	0.05
ONLY LUMBAR REGION	0,39
ONLY DORSAL REGION	0.05
BOTH DORSAL AND LUMBAR REGIONS.	99.50

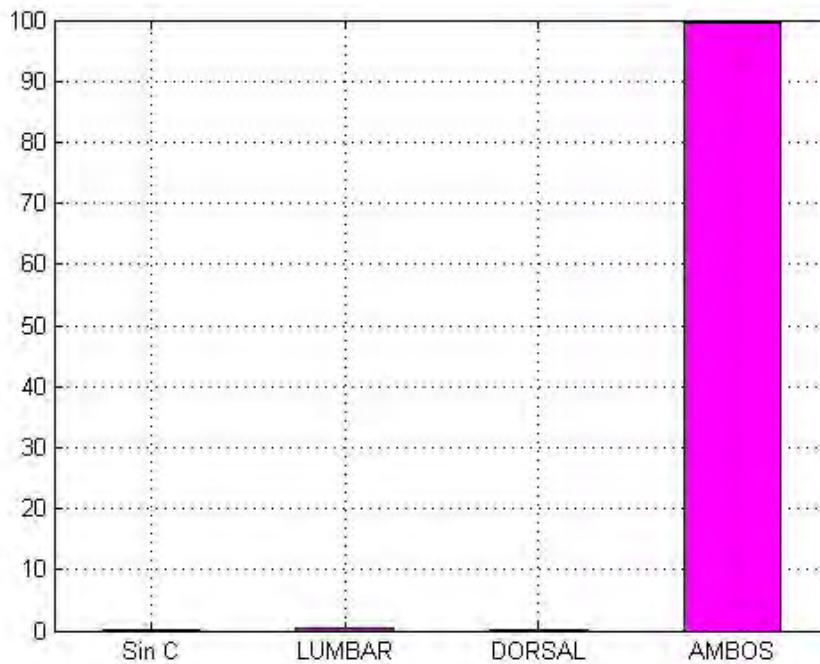

*Figure 10. Analysis of backrest use*

As a conclusion it is worth mentioning that the subjects in the tests remained in a position that allowed for the correct support of the back (only lumbar and both) for 99.39% of the time and the postures without contact and straight (only dorsal) accounting for 0.05% of the time and therefore the result is good.

**VALUATION OF THE ANALYSIS OF BACKREST USE - GOOD**

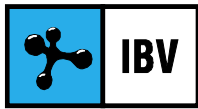

**ANNEX**

---

EVALUATION OF THE CHARACTERISTICS OF THE CHAIR

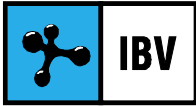

CHARACTERISTICS OF THE CHAIR EVALUATED BY THE SUBJECTS

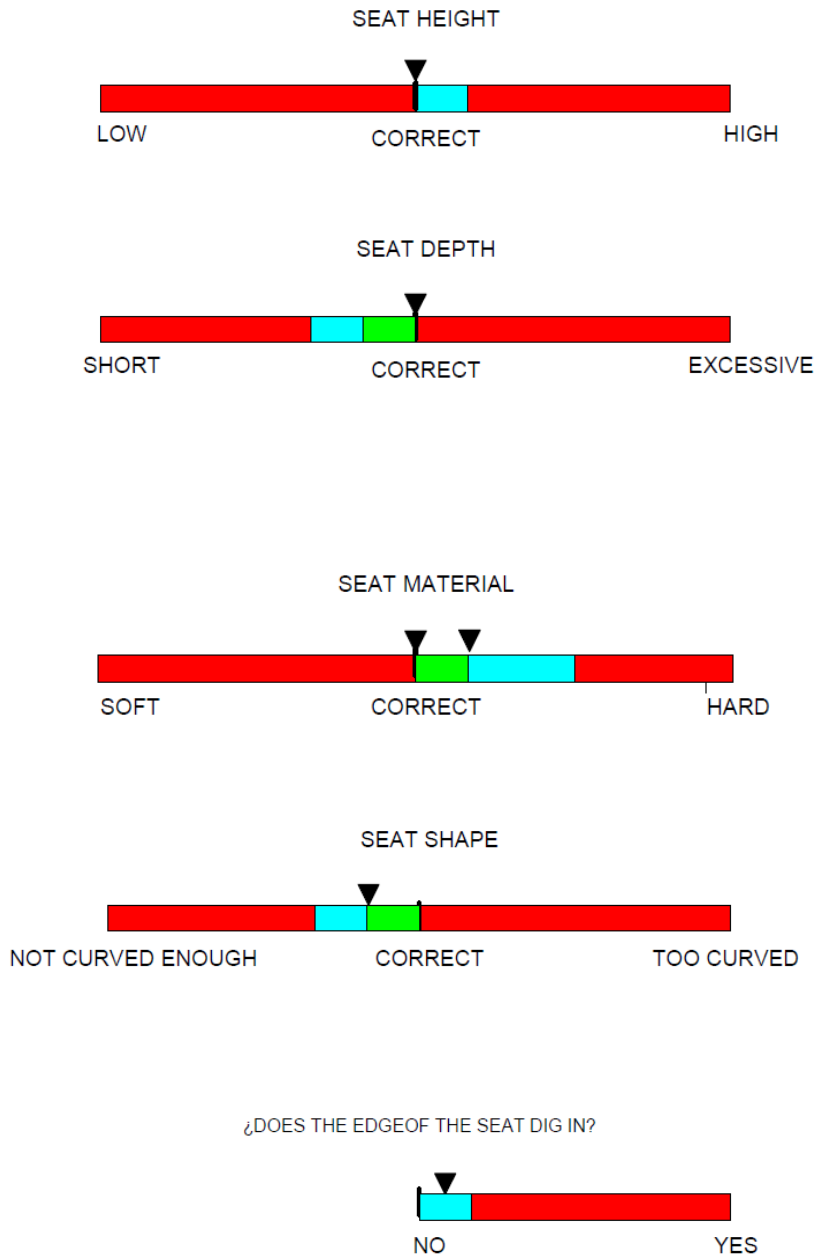

# IBV - TESTING

OFFICE CHAIR. ERGONOMIC EVALUATION

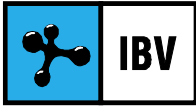

120119 - PV12/0186

---

## SEPARATION ARMRESTS

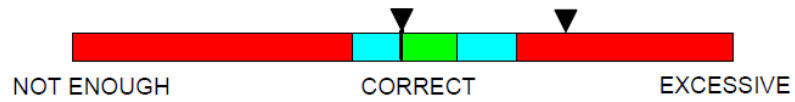

## ARMREST HEIGHT

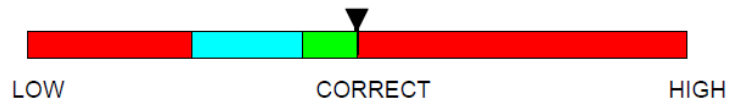

## ARMREST WIDTH

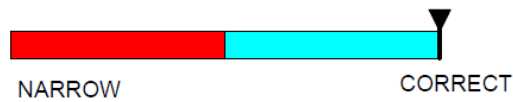

## ARMREST LENGTH

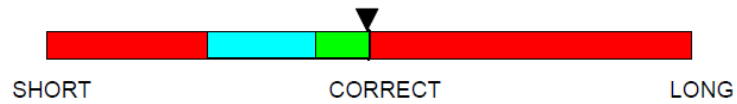

## SHAPE OF ARMREST



## BACKREST HEIGHT

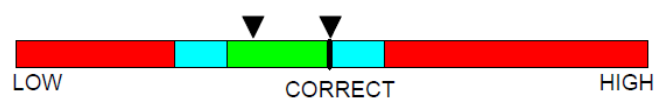



# IBV - TESTING

OFFICE CHAIR. ERGONOMIC EVALUATION

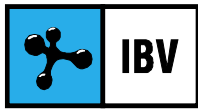

120119 - PV12/0186

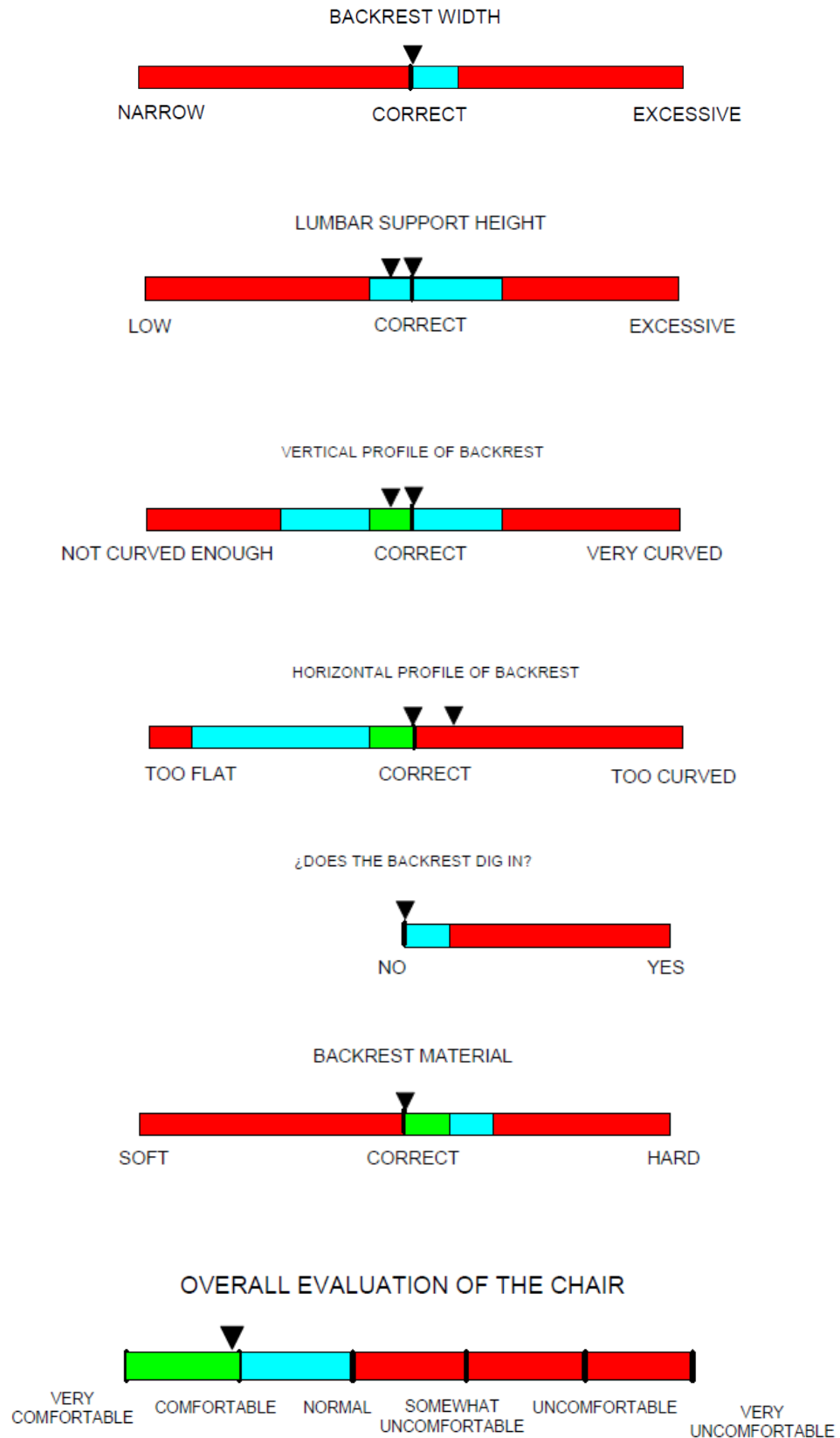



**MECHANISMS**

EASE OF SEAT HEIGHT REGULATION

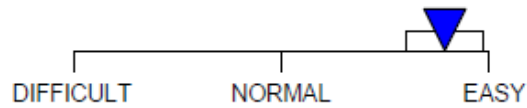

ACCES TO THE SEAT HEIGHT REGULATOR

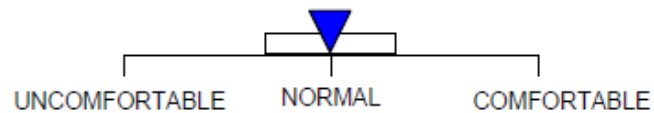

EASE OF SEAT DEPTH REGULATION

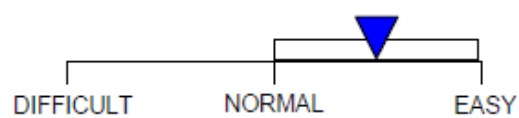

ACCES TO THE SEAT DEPTH REGULATOR

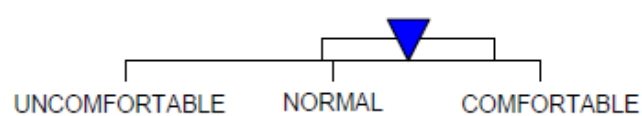

EASE OF LOCKING THE BACKREST TILT

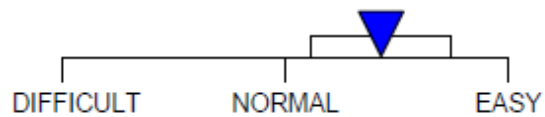

ACCESS TO THE BACKREST TILT LOCK CONTROL

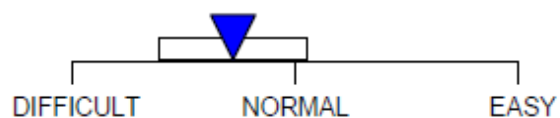



UNLOCK MOVEMENT OF BACKREST POSITION

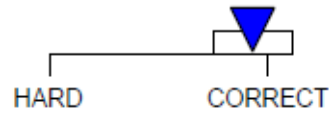

EASE LUMBAR SUPPORT REGULATION

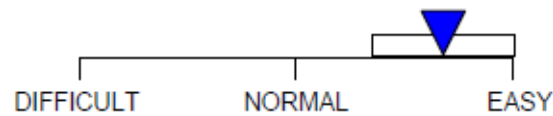

ACCESS TO THE LUMBAR SUPPORT REGULATOR

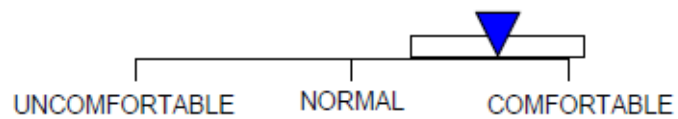

HARDNESS OF THE LUMBAR SUPPORT REGULATOR

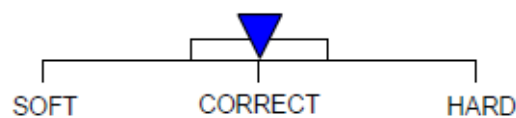

EASE OF REGULATING THE HEIGHT OF THE ARMRESTS

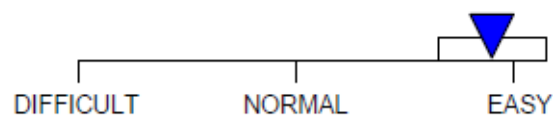

ACCESS TO THE ARMRESTS HEIGHT REGULATOR

